

EPJ5000



- Designed to work seamlessly with Broadcom's iLine 10[®] Series Chipset
- Thermo Plastic PBT UL94V-0 Rated Connector Housing
- Space saving Dual-Port RJ-11 Connector
- Operating Temperature : 0°C to +70°C
- 1500 Vrms Isolation

Electrical Parameters @ 25° C

Insertion Loss (dB Max.)	Return Loss (dB Min.)	Attenuation (dB Min.)			CMDR (dB Min.)
		@ 1.1 MHz	@ 22 MHz	@ 54 MHz	
4.25 MHz- 9.75 MHz	4.25 MHz- 9.75 MHz	@ 1.1 MHz	@ 22 MHz	@ 54 MHz	@ 200 KHz- 22 MHz
-2.2	-10	-60	-35	-50	-40

Package

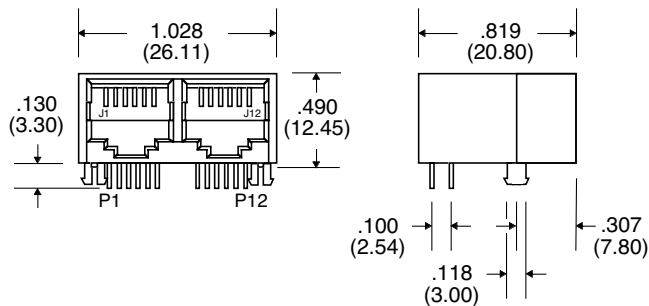

Schematic

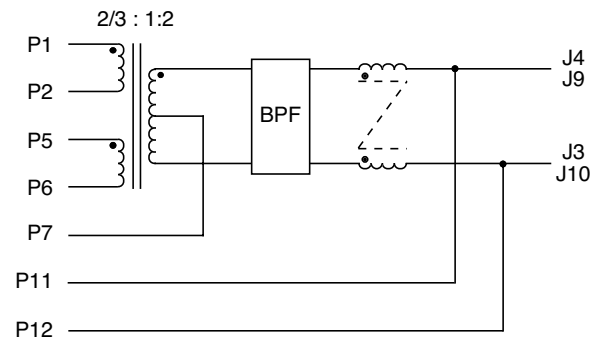

Suggested Pad Layout

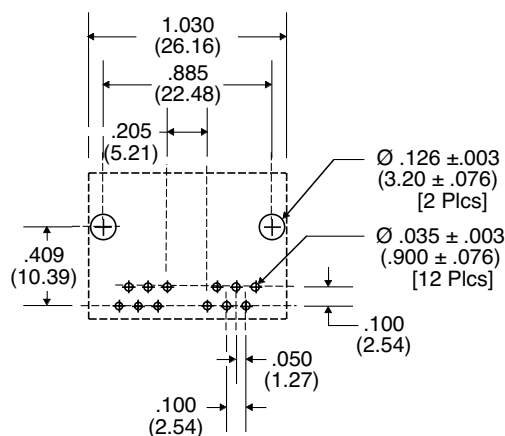

Unless Otherwise Specified Dimensions are in Inches /mm ± .010 / .25